

**Diaphragm valve DIASTAR Ten PVC-U
DA (Double acting)
Unions with solvent cement sockets metric**

Model:

- Double flow rate compared to predecessor
- One housing nut replaces four screws
- Rotating air connection at 90° intervals
- For easy installation and removal
- Short overall length

Option:

- Individual configuration of the valve (see diagram)
- Comprehensive range of accessories available
- PN16 available as a configuration

* PN: PTFE

Working Pressure: **one side**

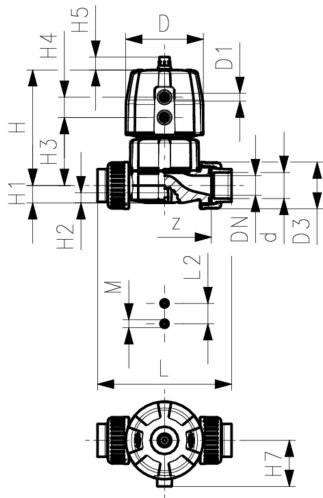

d (mm)	DN (mm)	PN* (bar)	kv-value ($\Delta p=1$ bar) (L/min)	EPDM Code	SP	Weight (kg)	PTFE/EPDM Code	SP	Weight (kg)
16	10	10/10*	125	161 654 011	1	0.526	161 654 031	1	0.536
20	15	10/10*	125	161 654 012	1	0.526	161 654 032	1	0.507
25	20	10/10*	271	161 654 013	1	0.923	161 654 033	1	0.922
32	25	10/10*	481	161 654 014	1	1.542	161 654 034	1	1.157
40	32	10/10*	759	161 654 015	1	2.521	161 654 035	1	1.816
50	40	10/10*	1263	161 654 016	1	3.250	161 654 036	1	2.994
63	50	10/10*	1728	161 654 017	1	4.732	161 654 037	1	3.961

d (mm)	D (mm)	D1_G (inch)	H (mm)	H1 (mm)	H2 (mm)	H3 (mm)	H4 (mm)	H5 (mm)	H7 (mm)	L (mm)	L2 (mm)	M	z (mm)	Lift = Hx (mm)
16	68	1/8	101	14	12	60	24	16	43	170	25	M6	142	7
20	68	1/8	101	14	12	60	24	16	43	128	25	M6	96	7
25	96	1/8	132	18	12	73	25	16	57	152	25	M6	114	10
32	96	1/8	143	22	12	84	25	16	57	166	25	M6	122	13
40	120	1/8	173	26	15	99	26	26	69	192	45	M8	140	15
50	150	1/4	214	32	15	119	36	26	88	222	45	M8	160	19
63	150	1/4	226	39	15	132	36	26	88	266	45	M8	190	23

d (mm)	closest inch (inch)
16	3/8
20	1/2
25	3/4
32	1
40	1 1/4
50	1 1/2
63	2

The technical data are not binding. They neither constitute expressly warranted characteristics nor guaranteed properties nor a guaranteed durability. They are subject to modification. Our General Terms of Sale apply.

Georg Fischer Piping Systems Ltd, Postfach, CH-8201 Schaffhausen/Switzerland
Phone +41 -(0)52-631 1111
e-mail: info.ps@georgfischer.com

Data sheet

valid from: 7/26/17



Internet: <http://www.gfps.com>